

river

LIGHTING



Wriver is a luxury furniture brand proudly made in India; making contemporary designs grounded in international sensibilities made conveniently accessible to the Indian market through its curated collection and with a range of customisation options.

At Wriver, we synergise rare craftsmanship and material innovation with comprehensive savoir-faire, to produce premium-quality, unmatched designs for empowering interiors.

Designed by: Studio Sumeet Nagi



OFFSET TABLE LAMP
IGNIS COLLECTION

Offset is a tall table lamp with a base in metal and the shade in Alabaster with brown veins. The metal base is distinguished by a fine ribbing pattern which is coated in an antique finish. The natural alabaster on the top is internally lit using warm white light, ensuring it receives even illumination.

OFFSET TABLE LAMP

Black Nickel Antique | White Alabaster with Brown Veins

OFFSET TABLE LAMP | IGNIS COLLECTION
Technical Information

Details

Top- In white alabaster with brown veins
Base- In metal with fluting

Available Size (In mm)

205 L x 204 D x 605 H

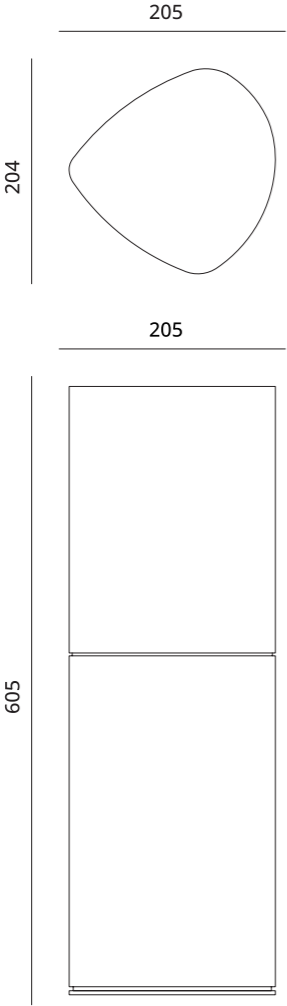

OFFSET TABLE LAMP | IGNIS COLLECTION
Materials and Finishes

Metal Finishes

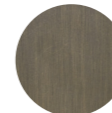
-  Black Nickel Antique
-  Brass Antique Dark

Stone Finishes

-  White Alabaster with Brown Veins



SETTO TABLE LAMP
IGNIS COLLECTION

Setto is a table lamp featuring a cast brass base, which is offered in either a blackened or an aged finish. The lamp's shade, shaped like a capsule, is crafted using white fabric and emits a cosy warm white glow. Casting on the base introduces a visual texture, lending a subtle design element to a timeless piece.

SETTO TABLE LAMP

CM 04 Aged Brass | White Fabric

SETTO TABLE LAMP | IGNIS COLLECTION
Technical Information

Details

Top- In fabric
Base- In cast metal

Available Size (In mm)

460 L x 300 D x 660 H

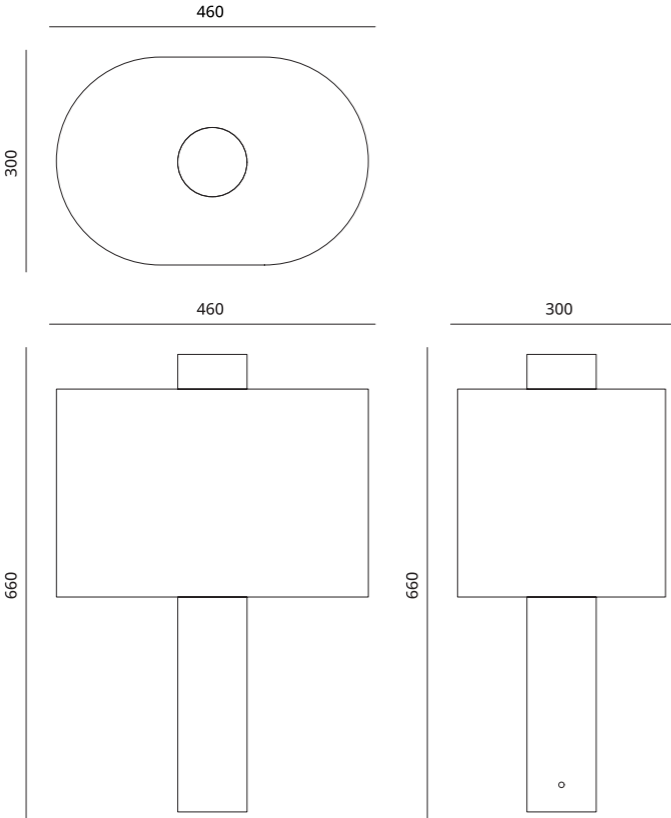

SETTO TABLE LAMP | IGNIS COLLECTION
Materials and Finishes

Metal Finishes

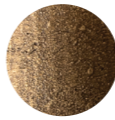

CM 04 Aged Brass

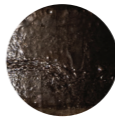

CM 04 Blackened Brass

Fabric



White Fabric



TIG I TABLE LAMP
IGNIS COLLECTION

The Tig series of lamps combines captivating visual and tactile textures, incorporating metal and wood elements. The Tig I Table Lamp features a white fabric shade combined with a brass base that showcases a grainy casting texture. The metal provides the choice of either a blackened or aged finish. The series includes table lamps and floor lamps, specifically named Tig I, Tig II & Tig III.

TIG I TABLE LAMP

CM 04 Aged Brass | White Fabric

TIG I TABLE LAMP | IGNIS COLLECTION
Technical Information

Details

Top- In fabric
Base- In cast metal

Available Size (In mm)

355 Dia x 530 H

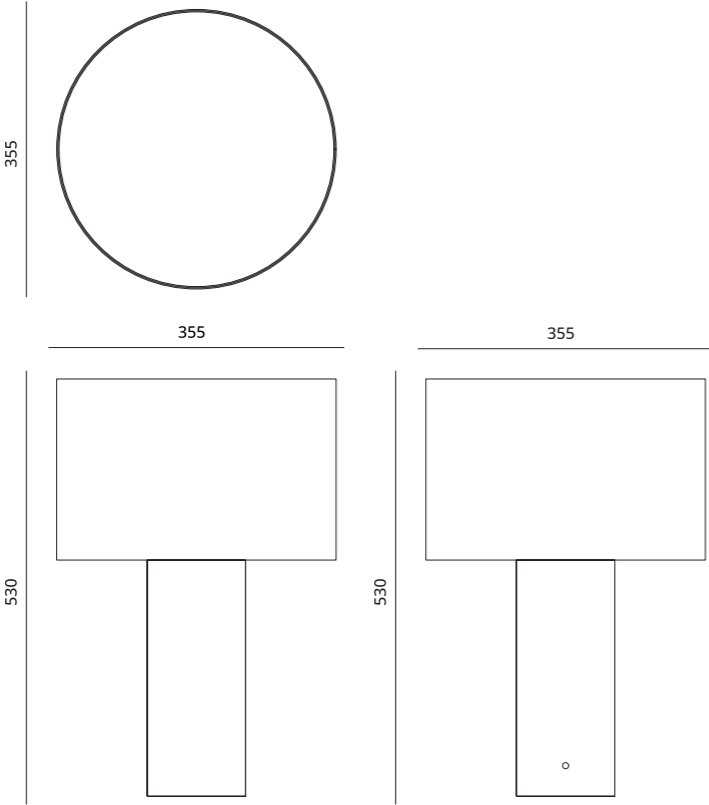

TIG I TABLE LAMP | IGNIS COLLECTION
Materials and Finishes

Metal Finishes

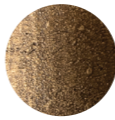

CM 04 Aged Brass

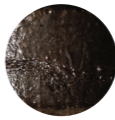

CM 04 Blackened Brass

Fabric



White Fabric



TIG II TABLE LAMP
IGNIS COLLECTION

The Tig series of lamps combines captivating visual and tactile textures, incorporating metal and wood elements. The Tig II Table Lamp features a white fabric shade combined with a brass base with an evident ridged texture. The metal provides the choice of either a blackened or aged finish. The series includes table lamps and floor lamps, specifically named Tig I, Tig II & Tig III.

TIG II TABLE LAMP

CM 05 Blackened Brass | White Fabric

TIG II TABLE LAMP | IGNIS COLLECTION
Technical Information

Details

Top- In fabric
Base- In cast metal with pattern detail

Available Size (In mm)

355 Dia x 530 H

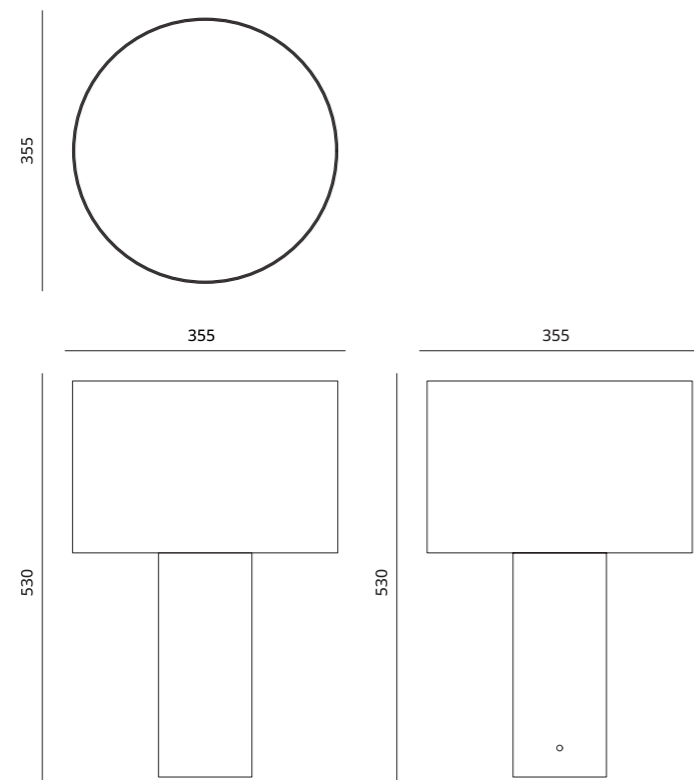

TIG II TABLE LAMP | IGNIS COLLECTION
Materials and Finishes

Metal Finishes

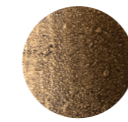

CM 05 Aged Brass

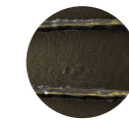

CM 05 Blackened Brass

Fabric



White Fabric



TIG III TABLE LAMP

GW 01- Black Stained | White Fabric

TIG III TABLE LAMP

IGNIS COLLECTION

The Tig series of lamps combines captivating visual and tactile textures, incorporating metal and wood elements. The Tig III Table Lamp showcases a white fabric shade harmoniously paired with a base that is carved from a single block of wood using a gouging technique. The gouged wood can be elegantly stained in black or walnut finishes, giving a touch of sophistication to the lamp's design. The series includes table lamps and floor lamps, specifically named Tig I, Tig II & Tig III.

TIG III TABLE LAMP | IGNIS COLLECTION
Technical Information

Details

Top- In fabric
Base- In gouged wood

Available Size (In mm)

355 Dia x 530 H

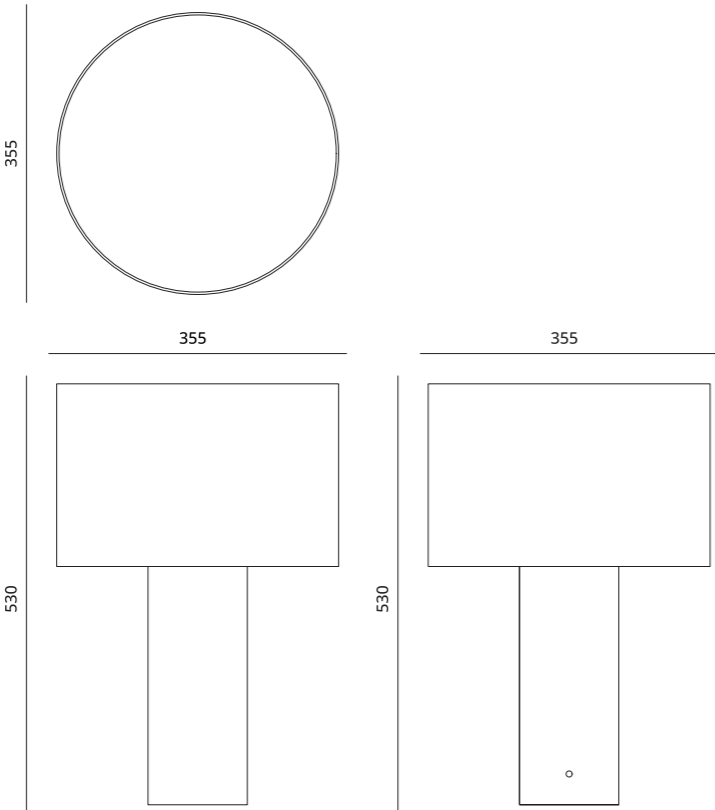

TIG III TABLE LAMP | IGNIS COLLECTION
Materials and Finishes

Special Finishes



GW 01- Black Stained



GW 01- Walnut Stained

Fabric



White Fabric



OFFSET FLOOR LAMP
IGNIS COLLECTION

The Offset Floor Lamp is a totem lamp with alternate units in alabaster & metal. Alabaster, the glowing component of the lamp, transmits warmth and looks beautiful even when turned off. Each alabaster piece in this towering structure is distinguished by its veins and thus, each lamp is unique as well. The beauty lies in the variation of its veins.

OFFSET FLOOR LAMP

Brass Antique Dark | White Alabaster with Brown Veins

OFFSET FLOOR LAMP | IGNIS COLLECTION
Technical Information

Details

Combination of Alabaster stone and metal

Available Size (In mm)

280 L x 335 D x 1880 H

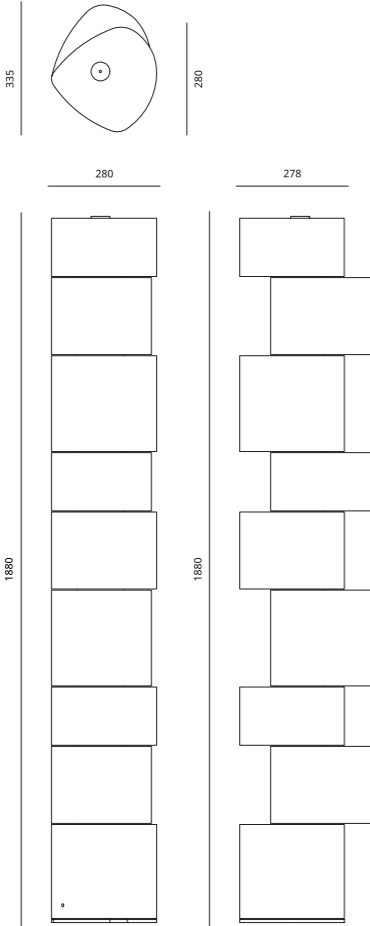

OFFSET FLOOR LAMP | IGNIS COLLECTION
Materials and Finishes

Metal Finishes



Black Nickel
Antique



Brass Antique
Dark



Brass Antique
Light

Stone Finishes



White Alabaster with
Brown Veins



LUNA TABLE LAMP
IGNIS COLLECTION

The Luna Table Lamp, glowing like the moon, is a table lamp with a soft triangle-shaped form when seen from the top. The illuminated part of the lamp rests on a contrasting black matt lacquered plinth. The shade can be custom-made in either alabaster or white fabric. In an interior space, the Luna Table Lamp and the Offset Floor Lamp make an excellent pair, as they both share a similar form.

LUNA TABLE LAMP

WR 009005 Matt | White Alabaster with Brown Veins

LUNA TABLE LAMP | IGNIS COLLECTION
Technical Information

Details

Top- In alabaster stone and fabric
Base- In lacquer

Available Size (In mm)

280 L x 280 D x 340 H

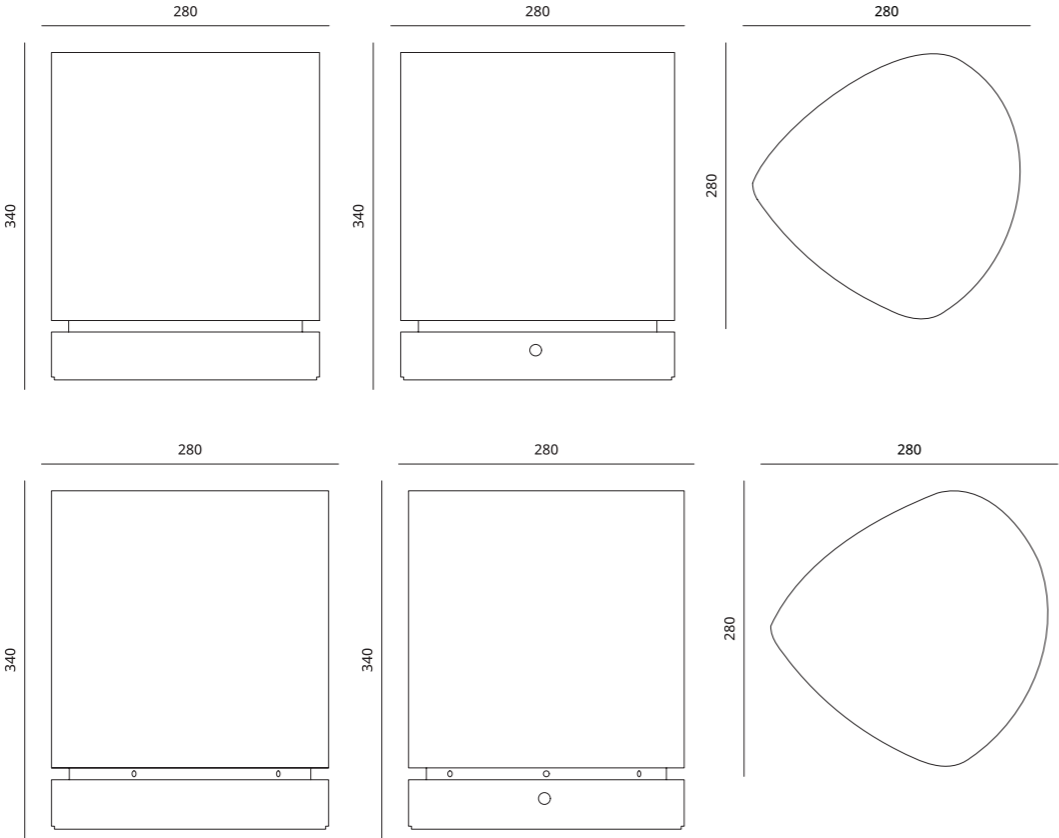

LUNA TABLE LAMP | IGNIS COLLECTION
Materials and Finishes

Lacquer Finishes



WR 009005 Matt

Stone Finishes



White Alabaster with
Brown Veins

Fabric



White Fabric



TIG I FLOOR LAMP
IGNIS COLLECTION

The Tig series of lamps combines captivating visual and tactile textures, incorporating metal and wood elements. The Tig I Floor Lamp features a white fabric shade combined with a brass base that showcases a grainy casting texture. The metal provides the choice of either a blackened or aged finish. The series includes table lamps and floor lamps, specifically named Tig I, Tig II & Tig III.

TIG I FLOOR LAMP

CM 04 Aged Brass | White Fabric

TIG I FLOOR LAMP | IGNIS COLLECTION
Technical Information

Details

Top- In fabric
Base- In cast metal

Available Size (In mm)

400 Dia x 1650 H

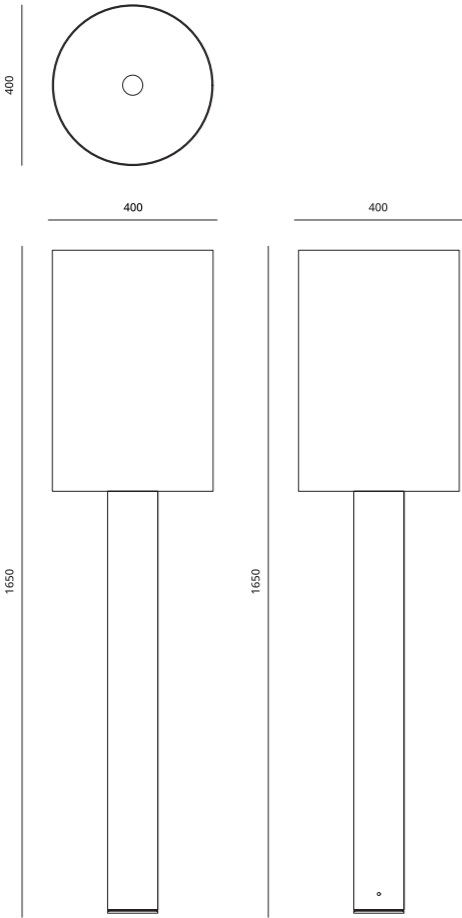

TIG I FLOOR LAMP | IGNIS COLLECTION
Materials and Finishes

Metal Finishes

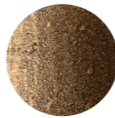

CM 04 Aged Brass

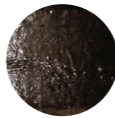

CM 04 Blackened Brass

Fabric



White Fabric



TIG II FLOOR LAMP

CM 05 Blackened Brass | White Fabric

TIG II FLOOR LAMP
IGNIS COLLECTION

The Tig series of lamps combines captivating visual and tactile textures, incorporating metal and wood elements. The Tig II Floor Lamp features a white fabric shade combined with a brass base with an evident ridged texture. The metal provides the choice of either a blackened or aged finish. The series includes table lamps and floor lamps, specifically named Tig I, Tig II & Tig III.

TIG II FLOOR LAMP | IGNIS COLLECTION
Technical Information

Details

Top- In fabric
Base- In cast metal with pattern detail

Available Size (In mm)

400 Dia x 1650 H

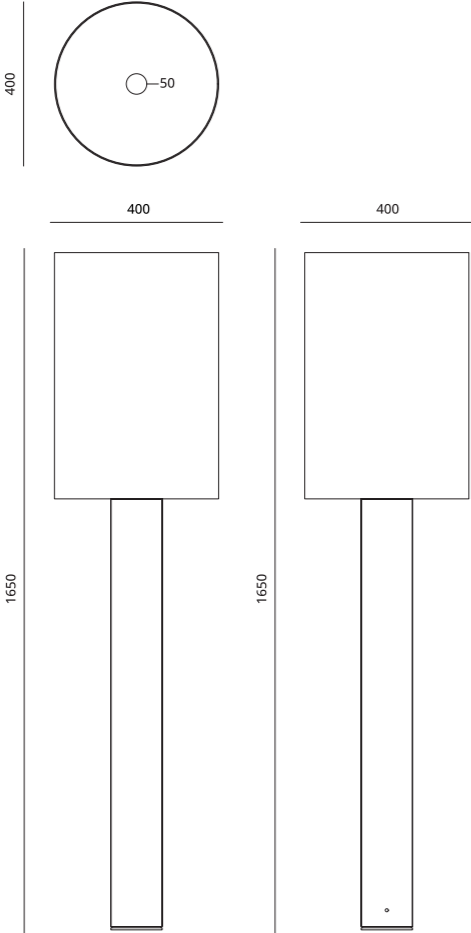

TIG II FLOOR LAMP | IGNIS COLLECTION
Materials and Finishes

Metal Finishes



CM 05 Aged Brass

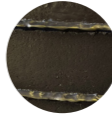

CM 05 Blackened Brass

Fabric



White Fabric



TIG III FLOOR LAMP

Brass Antique Wrinkled | GW 01 Walnut Stained | White Fabric

TIG III FLOOR LAMP

IGNIS COLLECTION

The Tig series of lamps combines captivating visual and tactile textures, incorporating metal and wood elements. The Tig III Floor Lamp showcases a white fabric shade harmoniously paired with a base that is carved from a single block of wood using a gouging technique. The gouged wood, which stands on a metal platform, can be elegantly stained in black or walnut finishes, giving a touch of sophistication to the lamp's design. The series includes table lamps and floor lamps, specifically named Tig I, Tig II & Tig III.

TIG III FLOOR LAMP | IGNIS COLLECTION

Technical Information

Details

Top- In fabric
Base- In gouged wood with metal border at the bottom

Available Size (In mm)

400 Dia x 1650 H

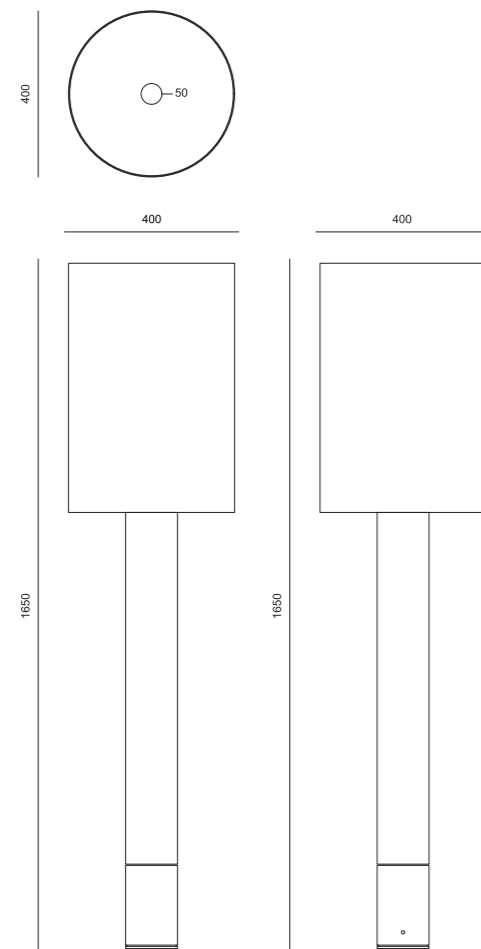

TIG III FLOOR LAMP | IGNIS COLLECTION

Materials and Finishes

Metal Finishes



Brass Antique
Wrinkled

Special Finishes

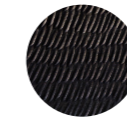

GW 01- Black
Stained



GW 01- Walnut
Stained

Fabric



White Fabric

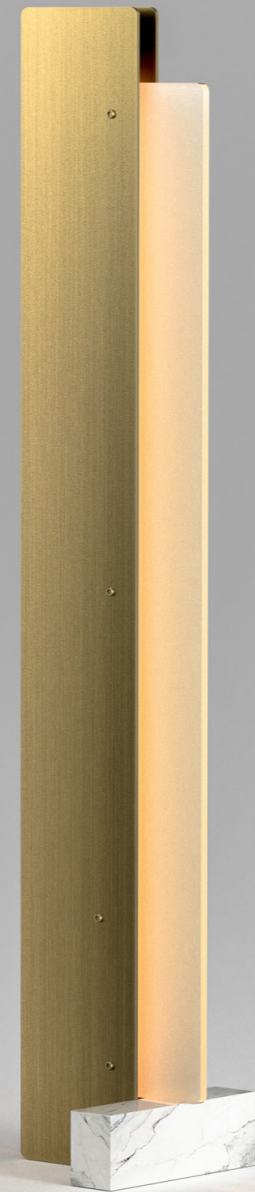

MIRAGE FLOOR LAMP
AMBIENTE COLLECTION

MIRAGE is a series of lighting products based on the concept of creating illusory effect through the fusion of parallel surfaces of metal and textured glass. The light passing through the edge of the glass defines its shape and provides indirect illumination. The oxidised metal panels with exposed joinery details gives a rustic appeal to the product. Mirage lights are available in various sizes based on utility; ranging from suspended, chandeliers to wall mounted sconces, and from free standing floor lamps to table lamps.

MIRAGE FLOOR LAMP

White Cararra (Polished) | Brass Antique Wrinkled | TG 01

MIRAGE FLOOR LAMP | AMBIENTE COLLECTION
 Technical Information

Details

Side Plates- In metal
 Structure- In wood
 Light- 3000K LED Light
 Glass- 8mm textured translucent glass
 Base- In stone

Available Size (In mm)

275 L x 275 D x 1550 H

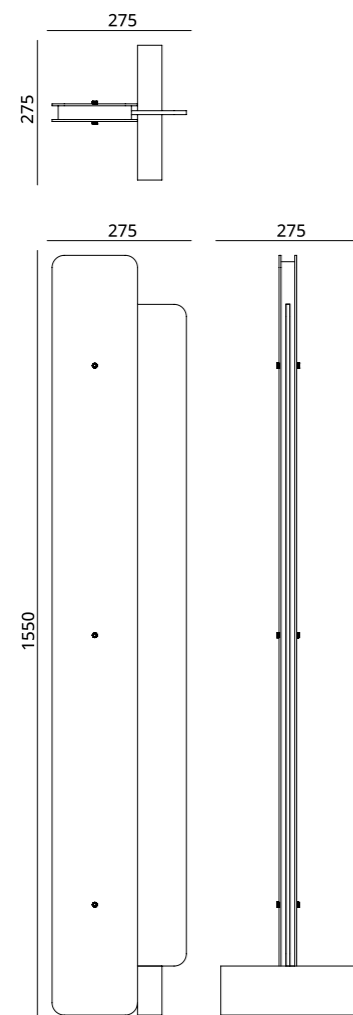

MIRAGE FLOOR LAMP | AMBIENTE COLLECTION
 Materials and Finishes

Metal Finishes



Stone Finishes

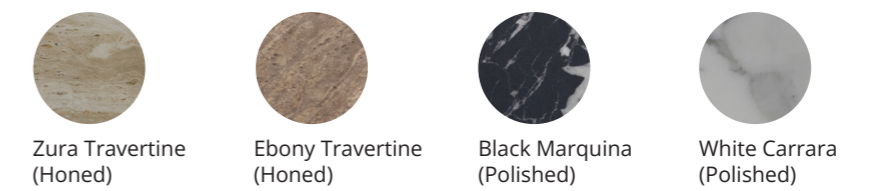

Lacquer Finishes

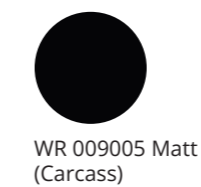

WR 009005 Matt
 (Carcass)

Glass Finishes

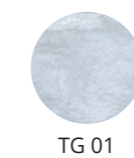

TG 01



MIRAGE TABLE LAMP
AMBIENTE COLLECTION

MIRAGE is a series of lighting products based on the concept of creating illusory effect through the fusion of parallel surfaces of metal and textured glass. The light passing through the edge of the glass defines its shape and provides indirect illumination. The oxidised metal panels with exposed joinery details gives a rustic appeal to the product. Mirage lights are available in various sizes based on utility; ranging from suspended, chandeliers to wall mounted sconces, and from free standing floor lamps to table lamps.

MIRAGE TABLE LAMP | AMBIENTE COLLECTION
 Technical Information

Details

Side Plates- In metal
 Structure- In wood
 Light- 3000K LED Light
 Glass- 8mm textured translucent glass
 Base- In stone

Available Size (In mm)

225 L x 150 D x 400 H

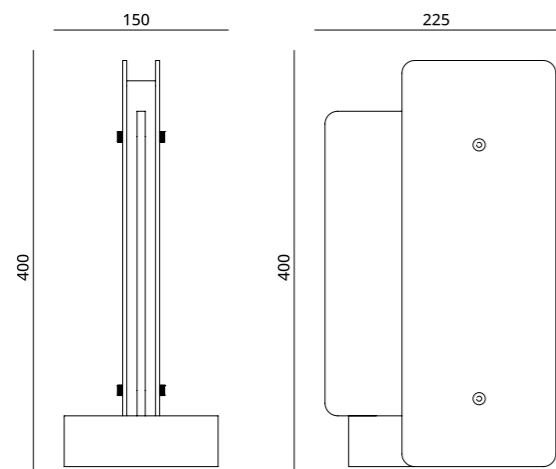
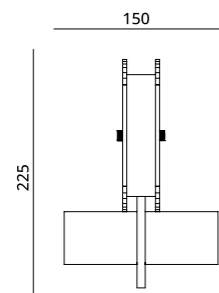

MIRAGE TABLE LAMP | AMBIENTE COLLECTION
 Materials and Finishes

Metal Finishes

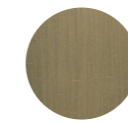

Brass Antique Light



Brass Antique Dark



Brass Antique Wrinkled



Copper Antique Light

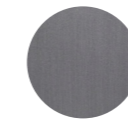

Black Nickel Antique

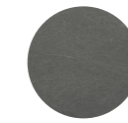

Black Nickel Antique Wrinkled



Copper Antique Wrinkled

Stone Finishes



Zura Travertine (Honed)



Ebony Travertine (Honed)



Black Marquina (Polished)

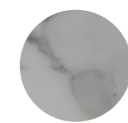

White Carrara (Polished)

Lacquer Finishes



WR 009005 Matt (Carcass)

Glass Finishes

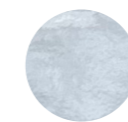

TG 01



MIRAGE SUSPENDED LAMP
AMBIENTE COLLECTION

MIRAGE is a series of lighting products based on the concept of creating illusory effect through the fusion of parallel surfaces of metal and textured glass. The light passing through the edge of the glass defines its shape and provides indirect illumination. The oxidised metal panels with exposed joinery details gives a rustic appeal to the product. Mirage lights are available in various sizes based on utility; ranging from suspended, chandeliers to wall mounted sconces, and from free standing floor lamps to table lamps.

MIRAGE SUSPENDED LAMP

Black Nickel Antique Wrinkled | TG 01



MIRAGE SUSPENDED LAMP

Brass Antique Wrinkled | TG 01

MIRAGE SUSPENDED LAMP | AMBIENTE COLLECTION
 Technical Information

Details

Side Plates- In metal
 Structure- In wood
 Light- 3000K LED light
 Glass- 8mm textured translucent glass
 suspended by clutch wire

Available Size (In mm)

400 L x 40 D x 225 H
 1550 L x 36 D x 275 H

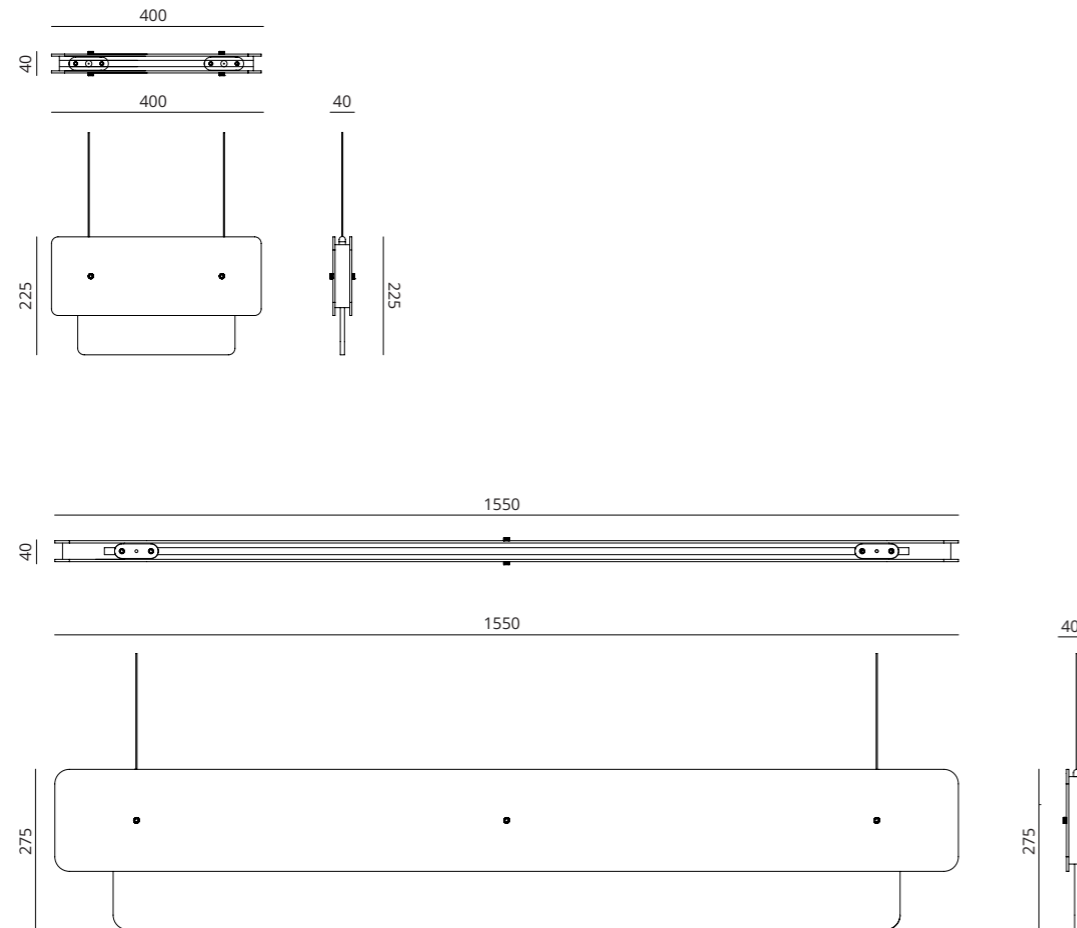

MIRAGE SUSPENDED LAMP | AMBIENTE COLLECTION
 Materials and Finishes

Metal Finishes



Lacquer Finishes

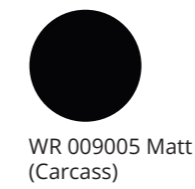

WR 009005 Matt
 (Carcass)

Glass Finishes



TG 01



MIRAGE WALL SCONCE
AMBIENTE COLLECTION

MIRAGE is a series of lighting products based on the concept of creating illusory effect through the fusion of parallel surfaces of metal and textured glass. The light passing through the edge of the glass defines its shape and provides indirect illumination. The oxidised metal panels with exposed joinery details gives a rustic appeal to the product. Mirage lights are available in various sizes based on utility; ranging from suspended, chandeliers to wall mounted sconces, and from free standing floor lamps to table lamps.

MIRAGE WALL SCONCE | AMBIENTE COLLECTION

Technical Information

Details

Side Plates- In metal
Structure- In wood
Light- 3000K LED light
Glass- 8mm textured translucent glass

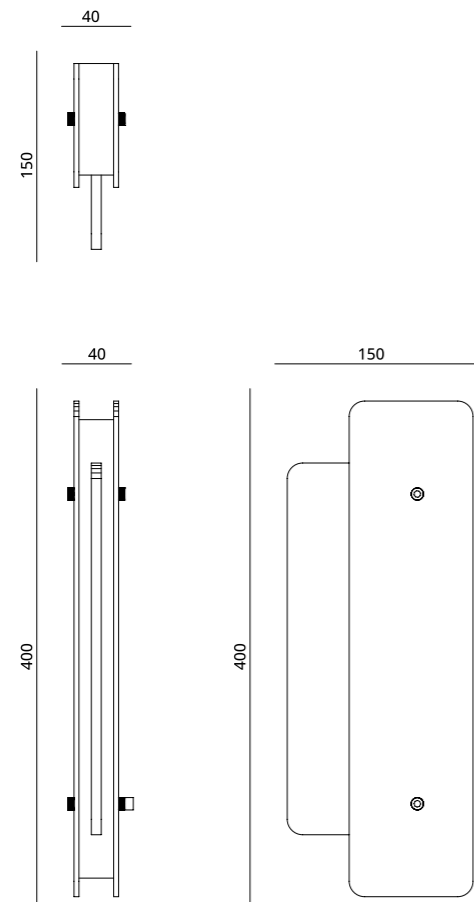

Available Size (In mm)

150 L x 40 D x 400 H

MIRAGE WALL SCONCE | AMBIENTE COLLECTION

Materials and Finishes

Metal Finishes



Lacquer Finishes

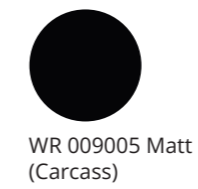

Glass Finishes

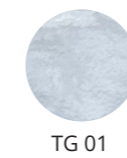



FARO FLOOR LAMP
AMBIENTE COLLECTION

Inspired from the traditional light-house with a structure that emits light from the top to assist navigation. FARO floor lamp presents a modern take on vintage industrial style. The perforated metal on the circular disk creates a classic illumination pattern over the light source, while it rotates around a pivot and swivels over a vertical pole, allowing it to adjust as per the required task. With an elegant fusion of craft and technology, Faro embodies a simple form that brings a sense of interaction, while the refined curvatures and a subtle use of materials create a familiar and comfortable visual appeal.

FARO FLOOR LAMP

Brass Antique Light | Brown Newood Eucalyptus Matt

FARO FLOOR LAMP | AMBIENTE COLLECTION
Technical Information

Details

Light Frame- In metal
Light Cover- Perforated sheet metal
Base- In veneer/ eco leather clad
Cutout & Base Trim- In metal

Available Size (In mm)

425 L x 260 D x 1480 H

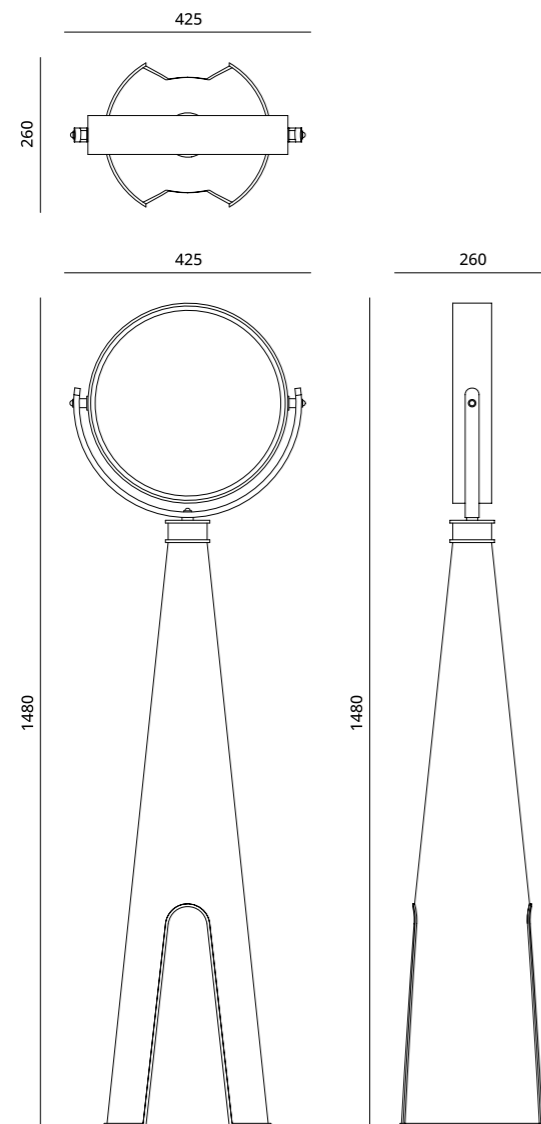

FARO FLOOR LAMP | AMBIENTE COLLECTION
Materials and Finishes

Metal Finishes

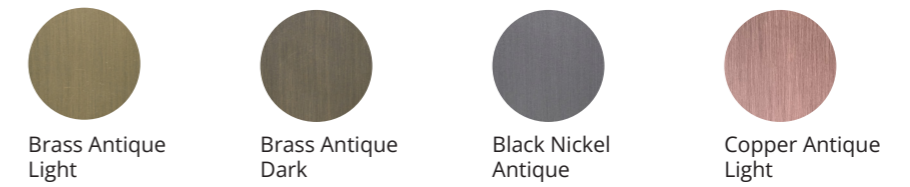

Wood / Veneer Finishes



Upholstery

Eco Leather options available on request



FARO SUSPENDED LAMP

Black Nickel Antique

FARO SUSPENDED LAMP
AMBIENTE COLLECTION

Inspired from the traditional light-house, FARO suspended lamp presents a modern take on vintage industrial style. The perforated metal on the circular disk creates a classic illumination pattern over the light source, while it rotates around a pivot, allowing it to adjust as per the required task. With an elegant fusion of craft and technology, Faro embodies a simple form that brings a sense of interaction; while the refined curvatures and a subtle use of materials create a familiar and comfortable visual appeal.

FARO SUSPENDED LAMP | AMBIENTE COLLECTION
Technical Information

Details

Frame- In metal
Light Cover- Perforated sheet Metal
Suspended by Clutch Wire

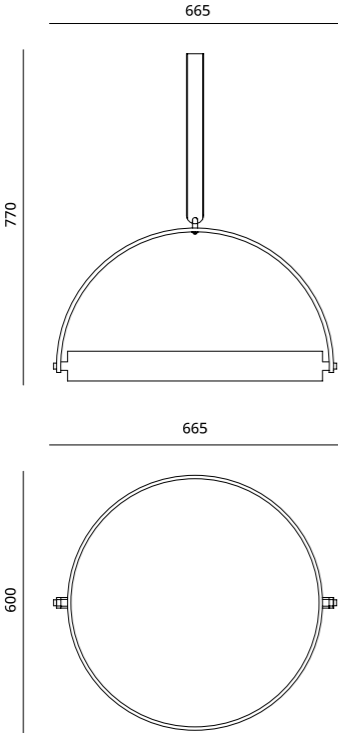

Available Size (In mm)

600 Dia

FARO SUSPENDED LAMP | AMBIENTE COLLECTION
Materials and Finishes

Metal Finishes

- Brass Antique Light
- Brass Antique Dark
- Black Nickel Antique
- Copper Antique Light

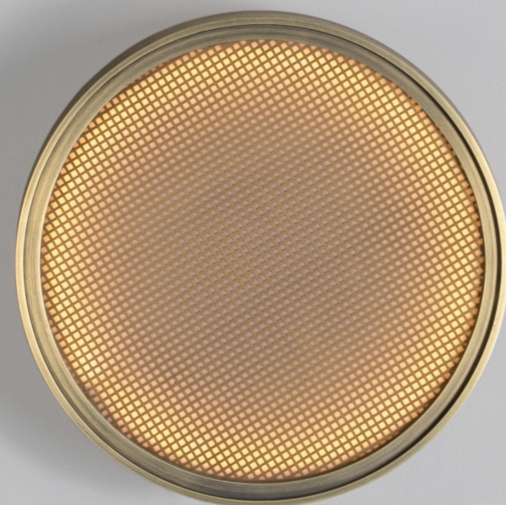

FARO WALL SCONCE

Brass Antique Dark

FARO WALL SCONCE
AMBIENTE COLLECTION

Inspired from the traditional lighthouse, FARO wall sconce presents a modern take on vintage industrial style. With perforated metal on the circular disk that creates a classic illumination pattern over the light source, Faro embodies a simple form with refined curvatures and a subtle use of materials that create a familiar and comfortable visual appeal.

FARO WALL SCONCE | AMBIENTE COLLECTION
Technical Information

Details

Frame- In metal
Light Cover- Perforated sheet metal

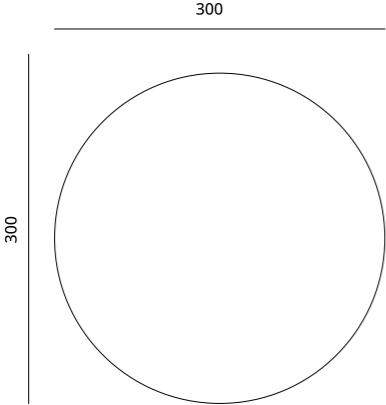
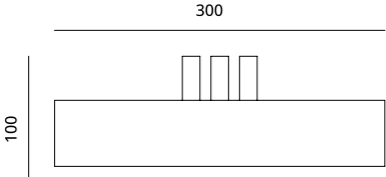

Available Size (In mm)

300 Dia x 100 D

FARO WALL SCONCE | AMBIENTE COLLECTION
Materials and Finishes

Metal Finishes

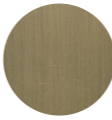

Brass Antique Light

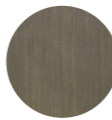

Brass Antique Dark



Black Nickel Antique



Copper Antique Light



FLECTO FLOOR LAMP

Brass Antique Dark | Eco Leather

FLECTO FLOOR LAMP
AMBIENTE COLLECTION

FLECTO derives its name from the curved surfaces that joins together to create a sleek linear form for the lamp. A unique combination of eco-leather and perforated metal adds texture and subtle drama, created by the interesting shadow on the surrounding walls and surfaces. Flecto lamps are a contemporary and stylish way to add a touch of industrial chic to any space and complement any decor style. They are available in various sizes based on utility, ranging from suspended lamps to wall sconces; and from standing floor lamps to table lamps.

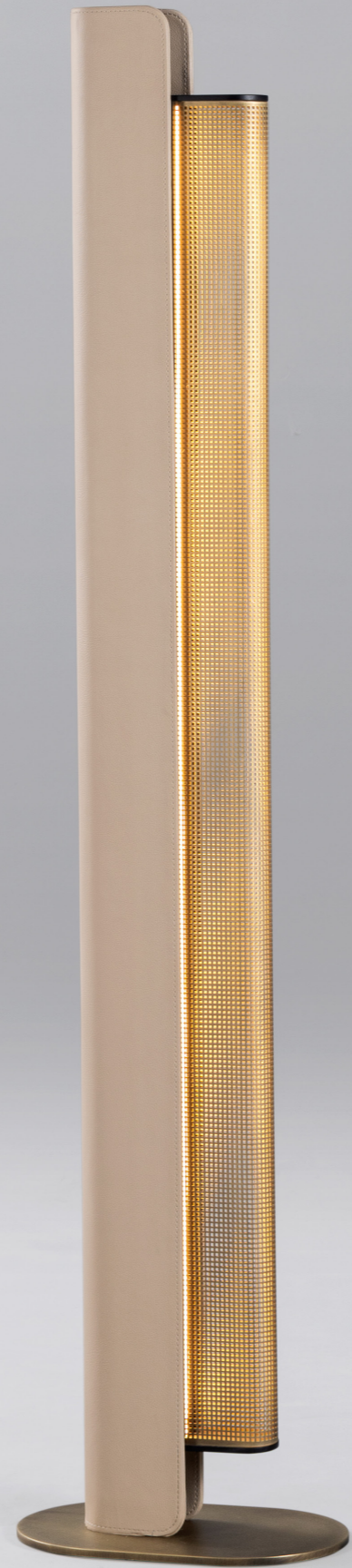

FLECTO FLOOR LAMP
Brass Antique Dark | Eco Leather

FLECTO FLOOR LAMP | AMBIENTE COLLECTION
Technical Information

Details

Structure- Cladded in eco leather
Base Plate- In sheet metal
Lamp Shade- In perforated sheet metal
layered with acrylic

Available Size (In mm)

325 L x 200 D x 1550 H

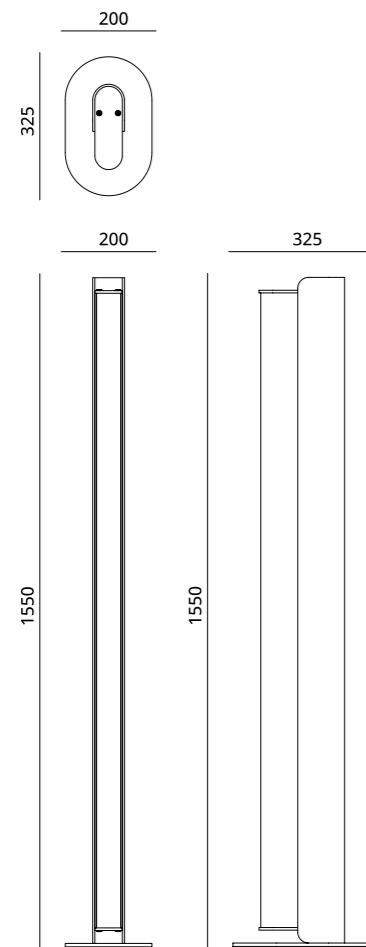

FLECTO FLOOR LAMP | AMBIENTE COLLECTION
Materials and Finishes

Metal Finishes

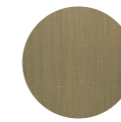

Brass Antique
Light

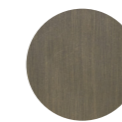

Brass Antique
Dark

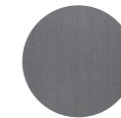

Black Nickel
Antique



Copper Antique
Light

Lacquer Finishes



WR 009005 Matt

Upholstery

Eco Leather options available on request



FLECTO TABLE LAMP
AMBIENTE COLLECTION

FLECTO derives its name from the curved surfaces that joins together to create a sleek linear form for the lamp. A unique combination of eco-leather and perforated metal adds texture and subtle drama, created by the interesting shadow on the surrounding walls and surfaces. Flecto lights/ lamps are a contemporary and stylish way to add a touch of industrial chic to any space and complement any decor style. They are available in various sizes based on utility, ranging from suspended lamps to wall sconces; and from floor lamps to table lamps.



FLECTO TABLE LAMP

Brass Antique Dark | Eco Leather

FLECTO TABLE LAMP | AMBIENTE COLLECTION
Technical Information

Details

Structure- In metal, clad with eco leather
Base- In metal
Lamp Shade- In perforated metal sheet
layered with acrylic

Available Size (In mm)

265 L x 150 D x 410 H

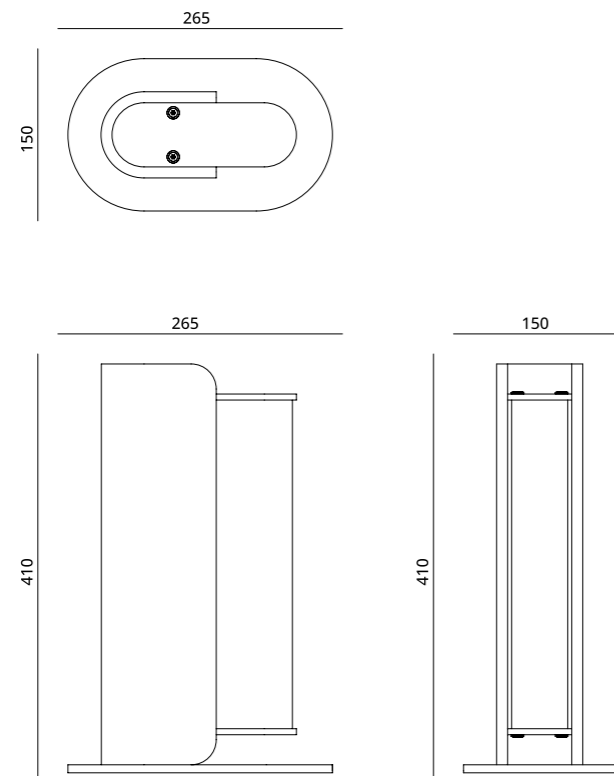

FLECTO TABLE LAMP | AMBIENTE COLLECTION
Materials and Finishes

Metal Finishes

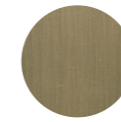

Brass Antique
Light

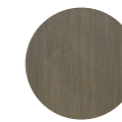

Brass Antique
Dark

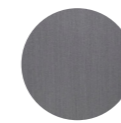

Black Nickel
Antique



Copper Antique
Light

Lacquer Finishes



WR 009005 Matt

Upholstery

Eco Leather options available on request

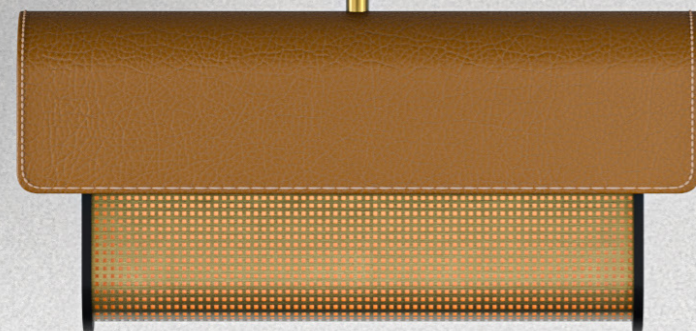

FLECTO SUSPENDED LAMP
AMBIENTE COLLECTION

FLECTO derives its name from the curved surfaces that joins together to create a sleek linear form for the lamp. A unique combination of eco-leather and perforated metal adds texture and subtle drama, created by the interesting shadow on the surrounding walls and surfaces. Flecto lights/ lamps are a contemporary and stylish way to add a touch of industrial chic to any space and complement any decor style. They are available in various sizes based on utility, ranging from suspended lamps to wall sconces; and from floor lamps to table lamps.

FLECTO SUSPENDED LAMP

Brass Antique Light | Eco Leather

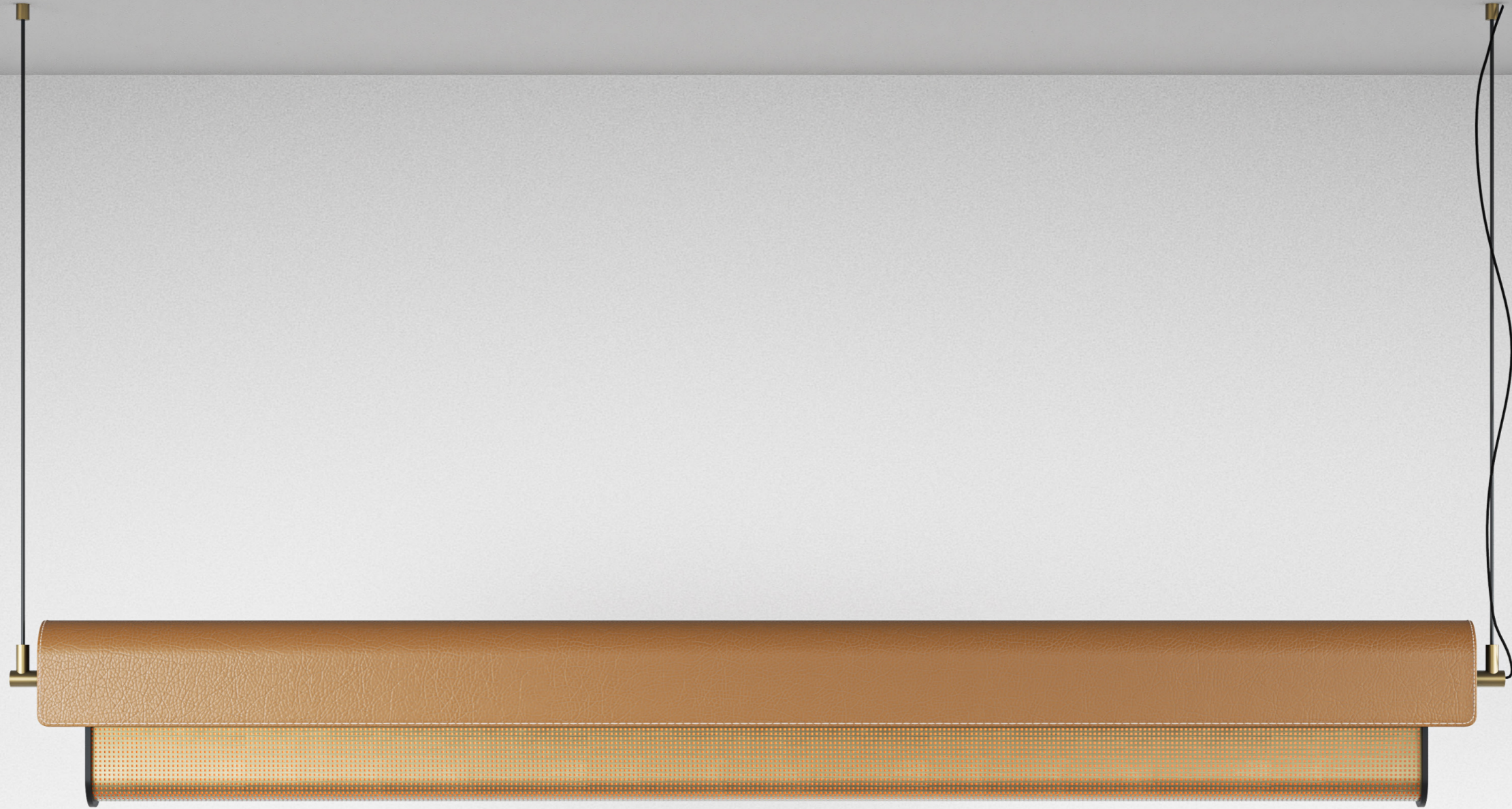

FLECTO SUSPENDED LAMP

Brass Antique Light | Eco Leather

FLECTO SUSPENDED LAMP | AMBIENTE COLLECTION
Technical Information

Details

Structure- In metal, clad with eco leather
Lamp Shade- In perforated metal sheet
layered with acrylic

Available Size (In mm)

460 L x 85 D x 205 H
1610 L x 85 D x 205 H

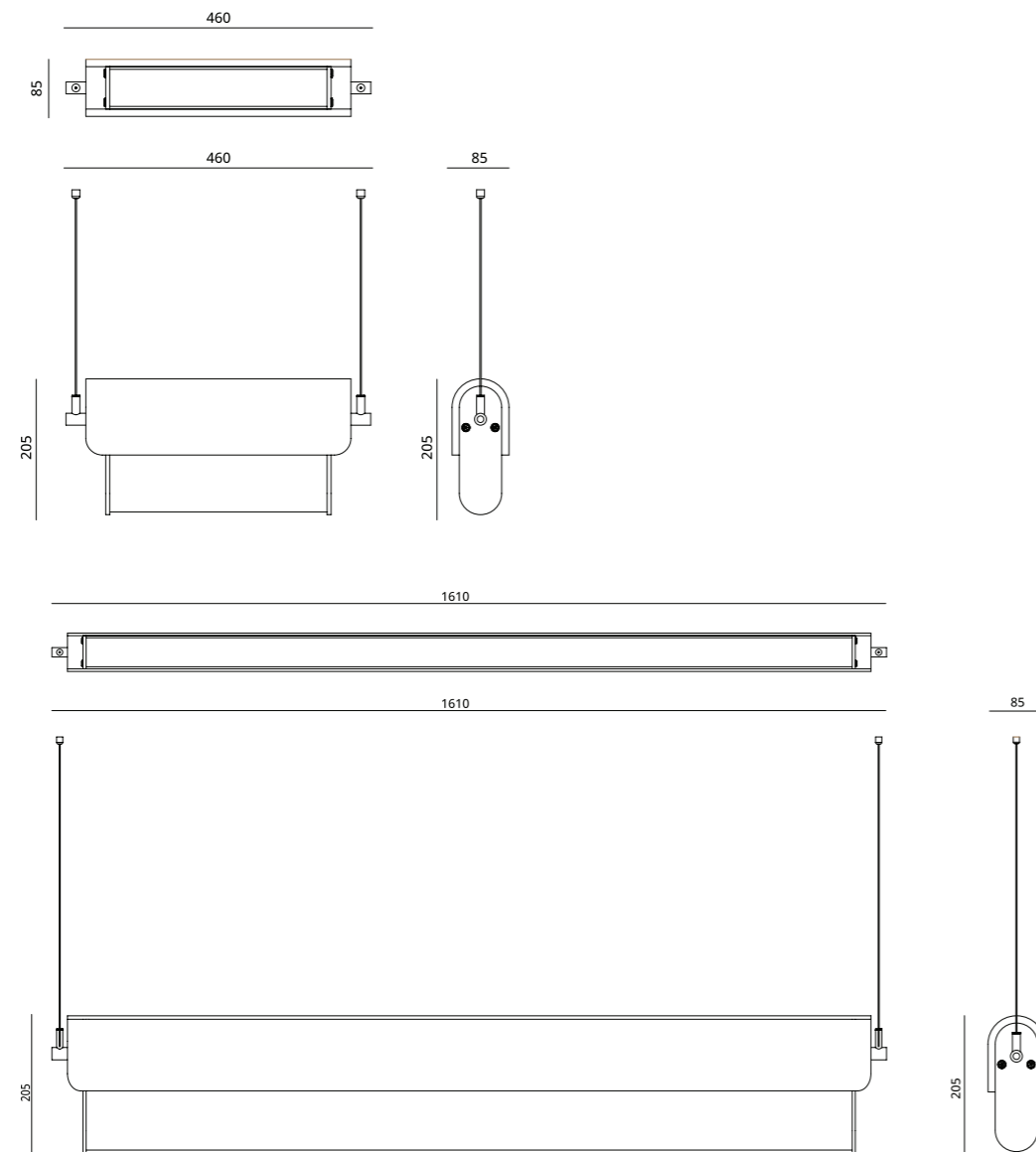

FLECTO SUSPENDED LAMP | AMBIENTE COLLECTION
Materials and Finishes

Metal Finishes



Brass Antique
Light

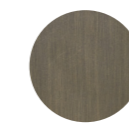

Brass Antique
Dark

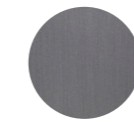

Black Nickel
Antique



Copper Antique
Light

Lacquer Finishes



Black Matt

Upholstery

Eco Leather options available on request

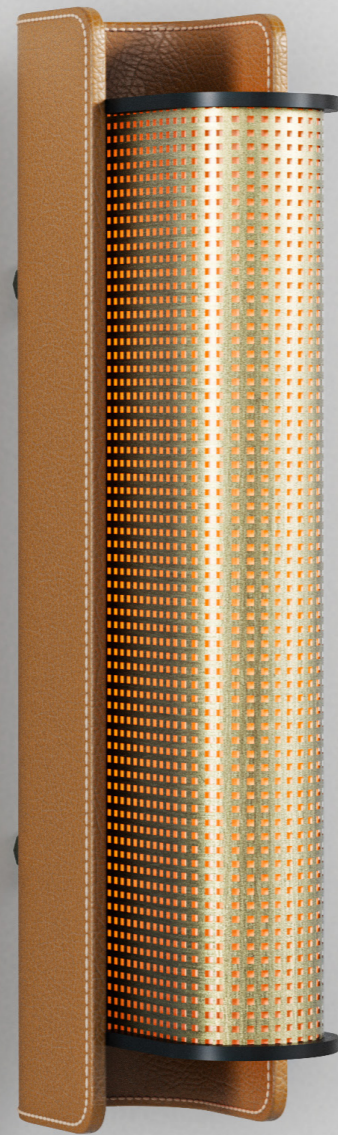

FLECTO WALL SCONCE
AMBIENTE COLLECTION

FLECTO derives its name from the curved surfaces that joins together to create a sleek linear form for the lamp. The broader leather clad curve envelops the narrower perforated metal curve developing the lampshade. A unique combination of leather and perforated metal adds texture and subtle drama, created by the interesting shadow on the surrounding walls and surfaces. Flecto lights/ lamps are a contemporary and stylish way to add a touch of industrial chic to any space and complement any decor style. They are available in various sizes based on utility, ranging from suspended pendants and chandeliers to wall mounted sconces; and from free standing floor lamps to table lamps.

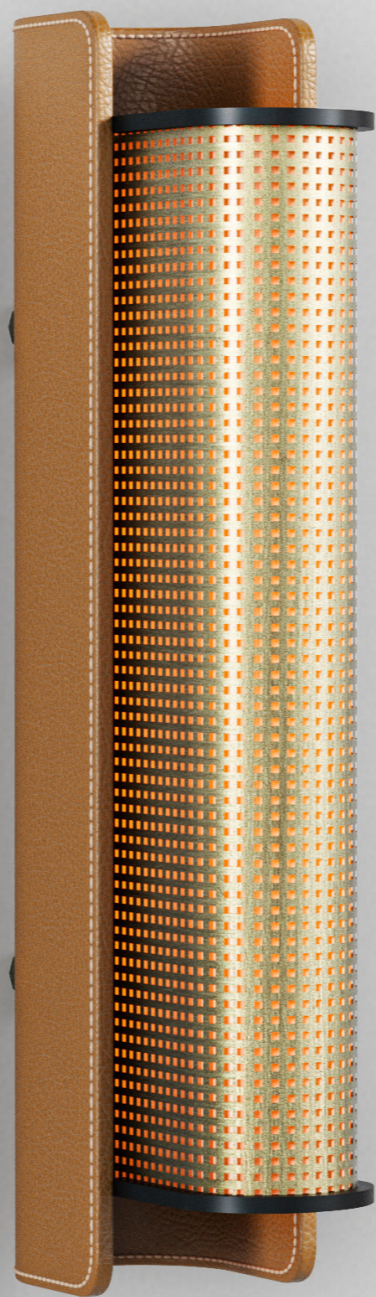

FLECTO WALL SCONCE

Brass Antique Light | Eco Leather

FLECTO WALL SCONCE | AMBIENTE COLLECTION
Technical Information

Details

Structure- In metal, clad with eco leather
Lamp Shade- In perforated metal sheet
layered with acrylic

Available Size (In mm)

160 L x 85 D x 400 H

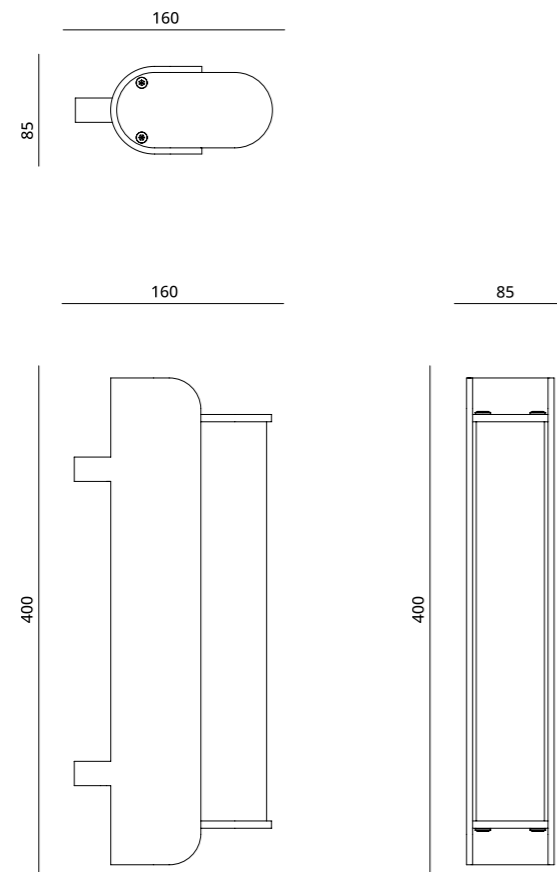

FLECTO WALL SCONCE | AMBIENTE COLLECTION
Materials and Finishes

Metal Finishes

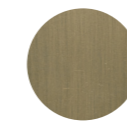

Brass Antique
Light

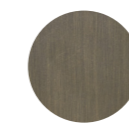

Brass Antique
Dark

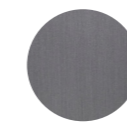

Black Nickel
Antique



Copper Antique
Light

Lacquer Finishes



WR 009005 Matt

Upholstery

Eco Leather options available on request